

Installation and Operating Manual

V13 R2.0-13

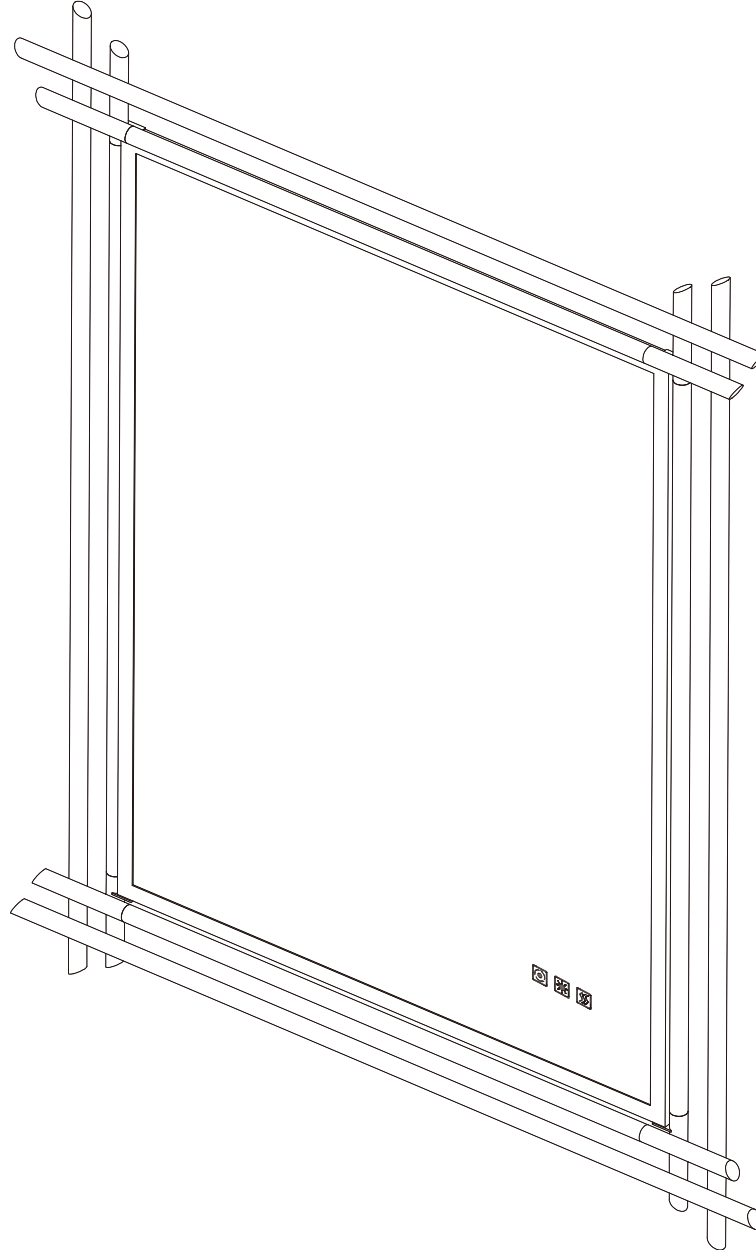

For technical support or questions, please call us at 800-498-4042.

Model Specification

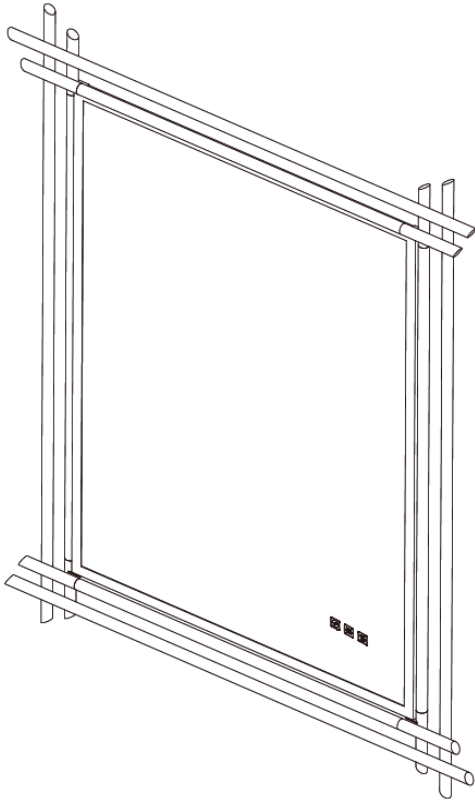

- **Color Temperature:3000-6000K**
- **Dimming**
- **Anti Fog**
- **Power Off Memory**

No.	SKU	Dimension	Finish	Remark
1	BMD2-3036-BK	30" X 36"	Black	
2	BMD2-3036-BB	30" X 36"	Brushed Brass	
3	BMD2-3036-PN	30" X 36"	Polished Nickel	
4	BMD2-4836-BK	48" X 36"	Brushed Brass	
5	BMD2-4836-BB	48" X 36"	Black	
6	BMD2-4836-PN	48" X 36"	Polished Nickel	

WARNING AND SAFETY INSTRUCTIONS

Before assembling your LED Lighted Mirror fixture, please make sure that you carefully read through this instruction sheet, refer back to them during installation to ensure your product is fitted safely and correctly. Keep these instructions for future use.

WARNING Risk of Fire and Electric Shock

- All fittings must be installed in accordance with current IEE wiring regulations. If in doubt, consult a qualified electrician.
- Switch off the electrical supply at the main circuit board BEFORE installation and maintenance.
- Suitable for indoor use only. This product should be positioned well away from curtains and fabrics. Never cover the mirror.
- Regularly check the cord, the transformer and all other parts for damage. If any part is damaged the product should not be used.

INSTALLATION SAFETY

- Inspect the product immediately upon receipt for the transit damage or missing parts. Handle the product with care and protect against knocks to all sides and edges of the glass.
- Ensure there are no hidden pipes or cables in the wall before drilling.
- Wear suitable eye protection when drilling. Take care if drilling on tiled surfaces in case the drill slips.



CAUTION

The light source of this product is non-changeable light diodes (LED). Do not disassemble the product, as the light diodes can cause damage to the eyes.

NOTE: The important safeguards and instructions that appear in this manual are not meant to cover all possible conditions and situations that may occur. It must be understood that common sense, caution and care, are factors that can't be built into any product. These factors must be supplied by the person(s) caring for and operating the fixture. Do not install this fixture in hazardous locations.

CHECK PRODUCT LIST AFTER OPENING THE PACKAGE

- LED Lighted Mirror --1pce
- Screw --5pcs
- Expansion Tube --5pcs
- Installation Manual --1pce
- Z-Bar --1pce

TOOLS YOU MAY NEED



INSTALLATION MANUAL

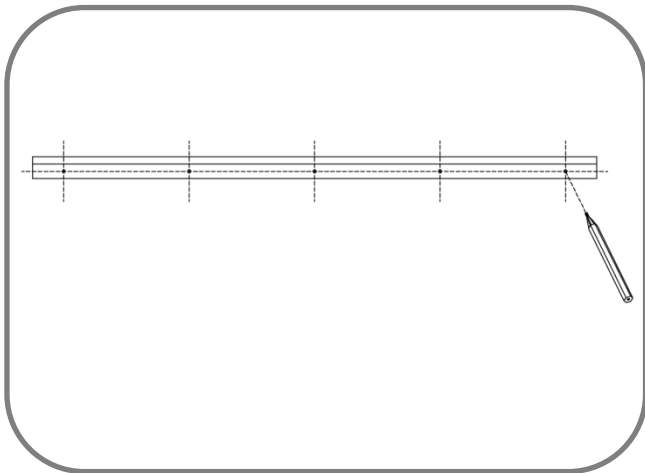

1

- Measure the center of the holes and mark the drilling locations.
- Ensure markings are leveled.

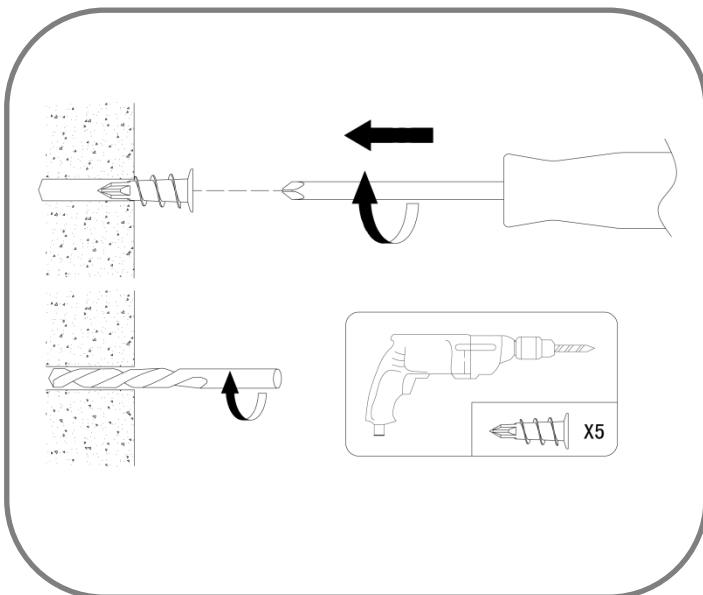

2

- Using a drill, make holes and fill with supplied wall plugs.

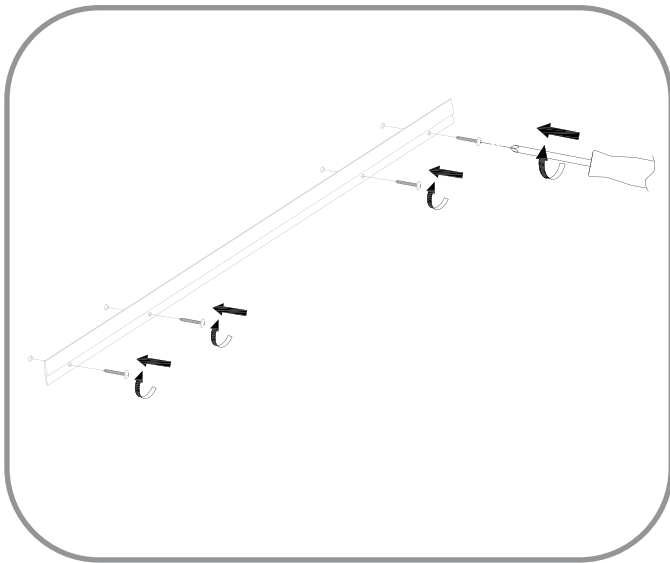

3

- Align the mounting bracket with the wall plug hole and screw the bracket to the wall.

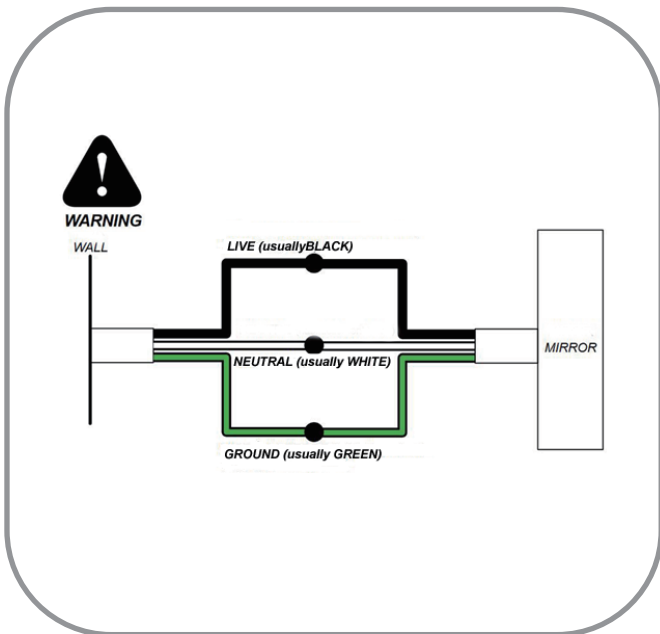

4

- Wiring
- ATTENTION: Please cut off the main power supply before wiring!

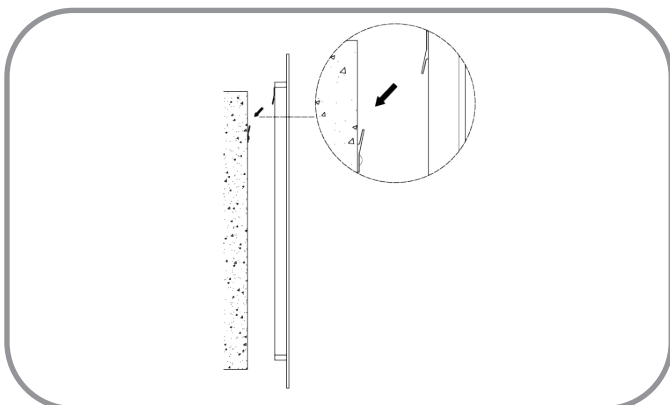

5

- Place the mirror against the wall and slide down as shown in image.

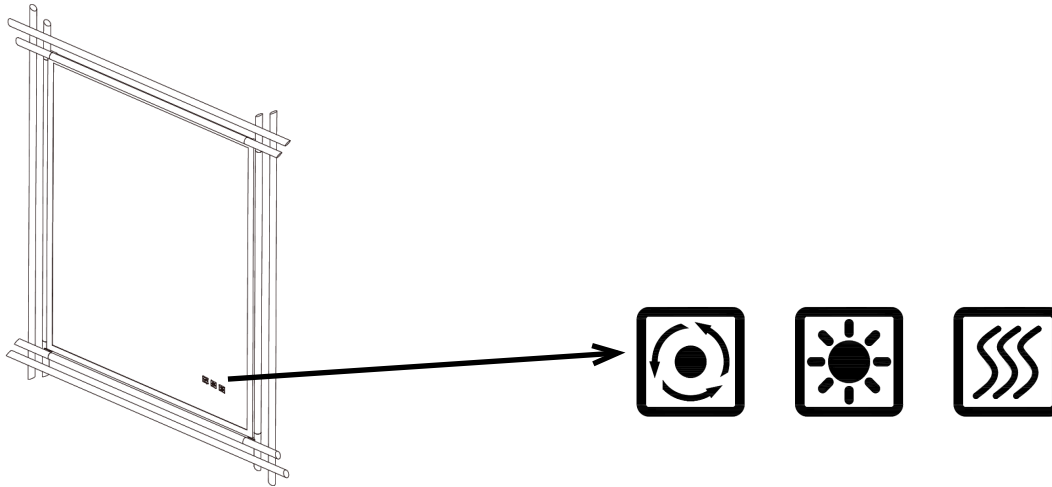

OPERATION INSTRUCTION

ON/OFF Function



ON/OFF button

- Briefly touch the button to turn the mirror on or off.
- Press and hold the button to change the color temperature when the mirror is on.
- Optional to be wired to wall switch by ON/OFF memory function.

Dimmer Function

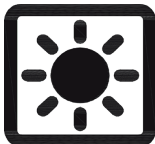

- Briefly touch the button to turn the mirror on or off.
- Press and hold the button to adjust the brightness.
- Release the button when the brightness reaches your desired level to set it.

Anti-Fog Function



- The mirror begins to warm up and defog after you press the defogger button.
- Press the button again to turn off the anti-fog function.
- **After turning off the defogger, press and hold the button to turn the blue backlight on or off.**
- **Note:** To prevent damage from prolonged high temperatures, the defogger will automatically stop after 60 minutes of continuous operation.

AFTERCARE INSTRUCTIONS

Clean using a soft dry cloth only when turned off. Never use cleaning agents or abrasive materials. Do not allow moisture to come into contact with lamp.

THANK YOU FOR YOUR SUPPORT.